

**BULLARD  
SOLAR**  
One with the Sun

**KONI  
SOLAR BOLLARD**





FIXTURE TYPE: \_\_\_\_\_

PROJECT NAME: \_\_\_\_\_



Parks & gardens



Pathways



Campsites

**CERTIFICATIONS**

**IEC / TUV / EMC / LM-79- 08  
AND LM-80 TEST STANDARDS  
/ IK8 / IP65 / CE / ULOR**

**5  
YEARS**

Bullard Solar offers a 5 Year Limited Warranty for the Solar Bollard-Series luminaire to be free from defects in material and workmanship for up to five (5) years from date of shipment. This limited warranty covers all components when installed and operated according to Bullard Solar instructions. Fixture suitable for ambient temperature from -10° to 50°. PV Panels - 20 year performance warranty Controller & Batteries: 5 years

**GENERAL INFORMATION:**

Designed in aluminum and treated to withstand the harshest conditions, the BULLARD SOLAR will be perfect for all your lighting, marking, and beautification applications for your outdoor living spaces with total energy autonomy. Equipped with high-efficiency solar cells, the light fixture charges in the sun but also in cloudy weather, ensuring optimal lighting throughout the year.

NOMINAL FLUX ..... 250 LUMENS  
NOMINAL POWER ..... 1.8 WATTS

**LIGHTING**

Efficiency ..... 120 Lumens/Watts  
Chips LED ..... PHILIPS Luxeon 30-30  
LED lifetime ..... Over 80 000 hours LM80  
Optics/CCT ..... T-V / 2300K to 6500K (Dual CCT optional)  
Light Height ..... 31.50" (80 cm)

**BATTERY**

Technology ..... Lithium Iron Phosphate LIFEP04  
Capacity ..... 28Wh  
Autonomy ..... Over 24 hours at full charge - 4 Rainy Days back up  
Charging time ..... 6 hours  
Lifespan ..... Over 3000 CYCLES @ 80% DOD over 10 years Lifetime  
Working temp ..... 14° F to 158° F (optional -40° F to 158 °F) -10°C to 70°C (optional -40°C TO 70°C )

**ENERGY**

Solar panel ..... 4.5 Wc  
Cells type ..... Monocrystalline Panel Grade A 25 years  
Certificates ..... IEC 61215 - IEC 61730 I and II - IEC 60904

**ELECTRONIC**

Sensor..... PIR 180° sensor (optional)

**DIMENSIONS**

Product ..... D: 8.27" x H: 31.50" (D: 21 cm x H: 80 cm)  
Carton size ..... 33.07" x 10.24" x 10.24" (84 cm x 26 cm x 26 cm)  
Weight ..... 13,45 lb (6.1 KG)  
Materials ..... Die cast aluminum  
Installation ..... Concrete base or insert on support  
Product code ..... SL-018

Bullard Solar retains the right to modify or change product specifications without prior notice, as part of our ongoing commitment to improvement

**ONE WITH THE SUN**

sales@gordonbullard.com  
www.bullardsolar.com  
1-877-964-4646



991 South Gull Lake Dr  
Richland, MI 49083  
USA

FIXTURE TYPE: \_\_\_\_\_

PROJECT NAME: \_\_\_\_\_

# LUMINAIRE & LEDS

The KONI bollard incorporates the latest LED technologies, its elegance and ease of installation will meet your lighting needs. KONI is equipped with LED chips, combining performance and robustness with 120 lumens per watt.

## A TOTAL OF 250 LUMENS

Our light fixture also complies with current standards concerning light pollution.



### SYMMETRICAL DISTRIBUTION

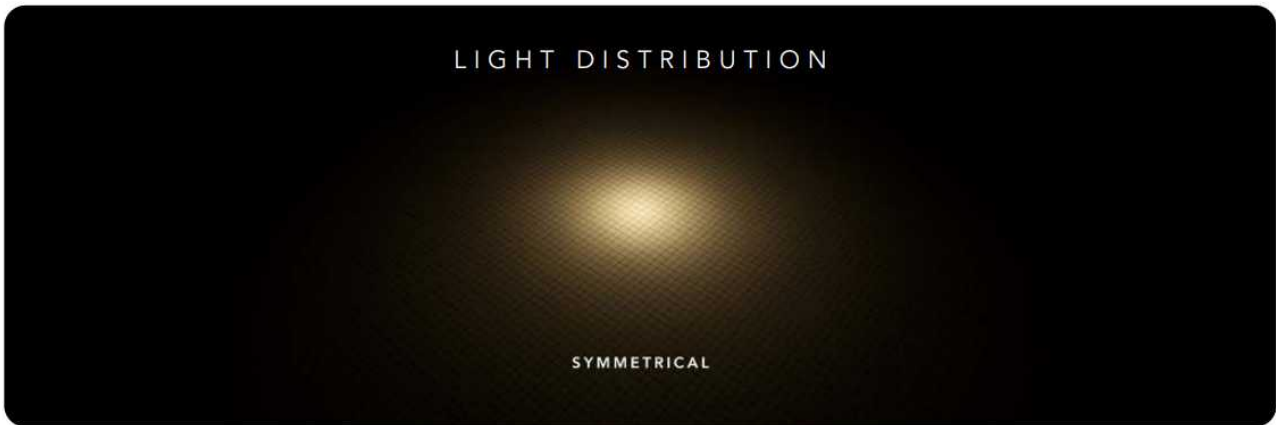

### PHOTOMETRIC CURVE

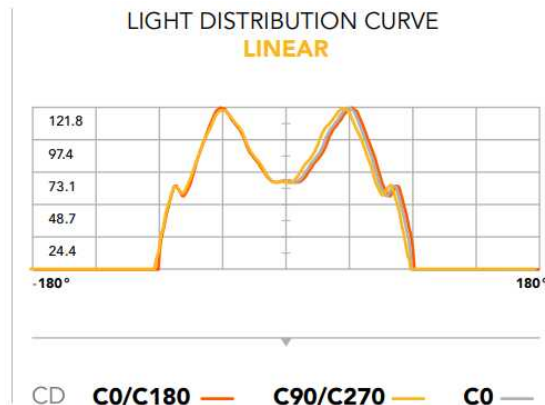
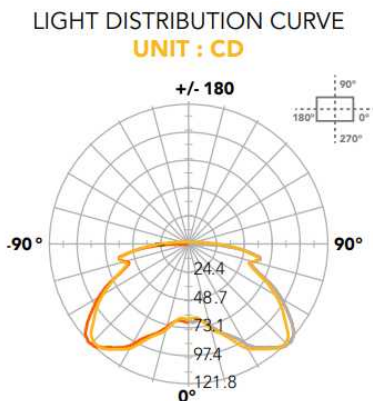

### ONE WITH THE SUN

sales@gordonbullard.com  
www.bullardsolar.com  
1-877-964-4646



991 South Gull Lake Dr  
Richland, MI 49083  
USA

FIXTURE TYPE: \_\_\_\_\_

PROJECT NAME: \_\_\_\_\_

## OVER 10 YEARS LIFESPAN

The KONI bollard is equipped with Lithium Iron Phosphate LIFEPO4 batteries, recognized as the best battery technology in terms of longevity, safety, and performance for solar applications. Our batteries enjoy a lifespan of over 3000 cycles, which is more than 10 years at 80% DOD.

## EXTREME TEMPERATURE

14°F to 158°F  
-10 °C to 70 °C

While standard batteries benefit from an operating temperature of -10°C to 70°C, Bullard Solar offers as optional a new Special LIFEPO4 battery with working range of -40°F to 158°F / -40°C to 70°C .

# BATTERY LIFEPO4



## BMS ELECTRONIC PROTECTION BATTERY MANAGEMENT SYSTEM

Our batteries are equipped with electronic circuit boards for a higher protection, ensuring battery functioning optimization in any situation.

THE BMS PROTECTS AGAINST

OVER/UNDER CURRENT • OVERLOAD • OVER/UNDER VOLTAGE  
• OVER/UNDER CHARGE • TEMPERATURE MANAGEMENT

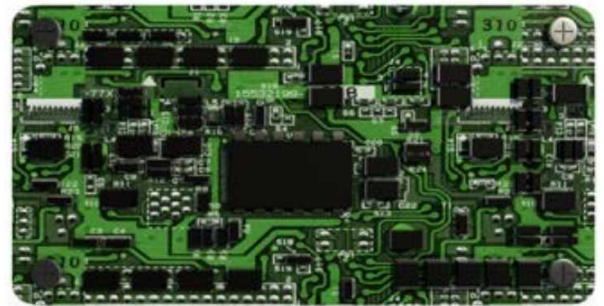

## COMPARISONS OF DIFFERENT BATTERY TECHNOLOGIES

**LIFETIME & CYCLES AT 80% DOD\***  
*Comparison of different battery technologies*



Lead Acid  
**200**



NimH  
**700**



Lithium ION  
**800**



Lithium LifePO4  
**3 000**

**CHARGING TEMPERATURE RANGE  
WITHOUT CAPACITY LOSS**  
*Minimum & Maximum temperature range for  
Optimal charging during the day*

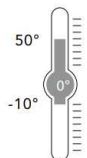

Lead Acid

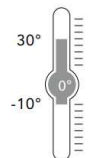

NimH

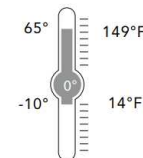

Lithium ION

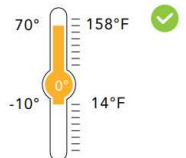

Lithium LifePO4

### ONE WITH THE SUN

sales@gordonbullard.com  
www.bullardsolar.com  
1-877-964-4646



991 South Gull Lake Dr  
Richland, MI 49083  
USA

FIXTURE TYPE: \_\_\_\_\_

PROJECT NAME: \_\_\_\_\_

# SOLAR PANEL

**4.5 WATTS**

Encapsulated Monocrystalline Solar Panel Grade A Solar Cell with Tempered Glass.

Solar cells **GRADE A**



## OUR PV PERFORMANCE GUARANTEE

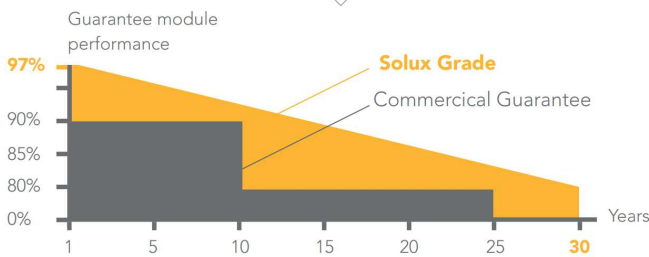

# PRESENCE DETECTOR INFRA-RED SENSOR

THE KONI BOLLARD AUTOMATICALLY TURNS ON AT DUSK AND OFF AT DAWN.

BULLARD SOLAR offers optional PIR movement sensor. The infra red detector integrated into the light fixture will increase the light power as pedestrians or vehicles pass, thus providing a higher level of safety while respecting the environment.

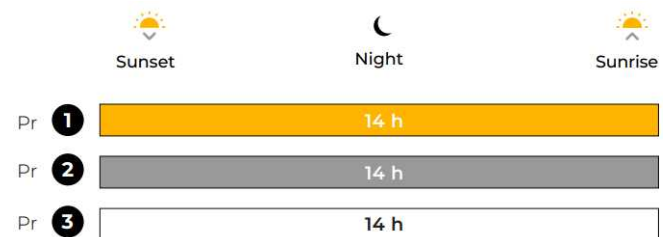
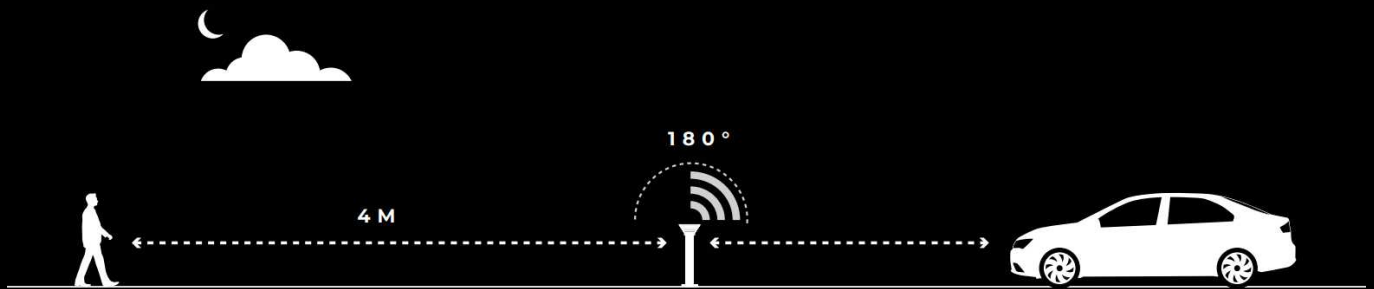

Depending on the geographical area, we will select the % of light reduction.

- Program 1 > 40% Dim + 100% ON during 20 sec
- Program 2 > 30% Dim + 100% ON during 20 sec
- Program 3 > 20% Dim + 100% ON during 20 sec

ONE WITH THE SUN

sales@gordonbullard.com  
www.bullardsolar.com  
1-877-964-4646



991 South Gull Lake Dr  
Richland, MI 49083  
USA



**BULLARD  
SOLAR**  
One with the Sun

**CODE:  
SL-018**

FIXTURE TYPE: \_\_\_\_\_

PROJECT NAME: \_\_\_\_\_

# EASY INSTALLATION

## NO CABLING & TRENCHING

No wiring or trenching is necessary, you just need to embed the KONI on anchor rods.

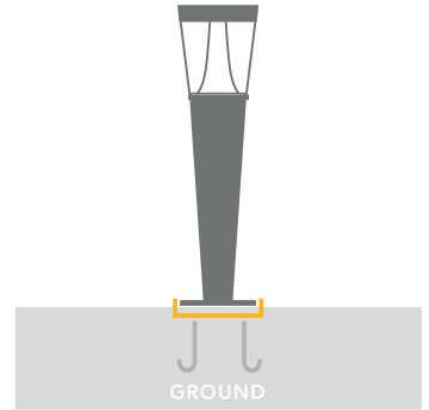

FLAT MOUNT

# DIMENSIONS

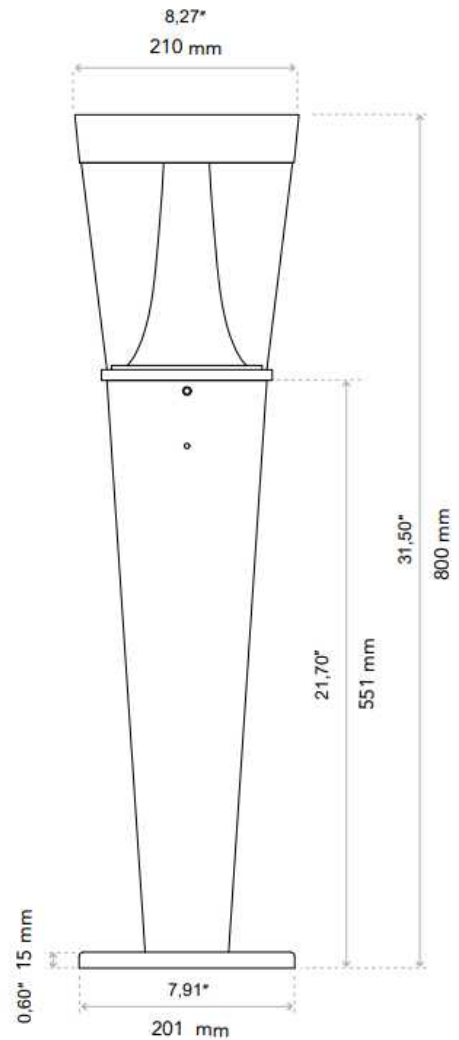
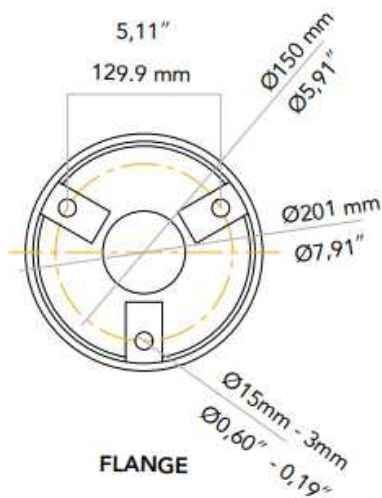

**ONE WITH THE SUN**

sales@gordonbullard.com  
www.bullardsolar.com  
1-877-964-4646



991 South Gull Lake Dr  
Richland, MI 49083  
USA



FIXTURE TYPE: \_\_\_\_\_

PROJECT NAME: \_\_\_\_\_

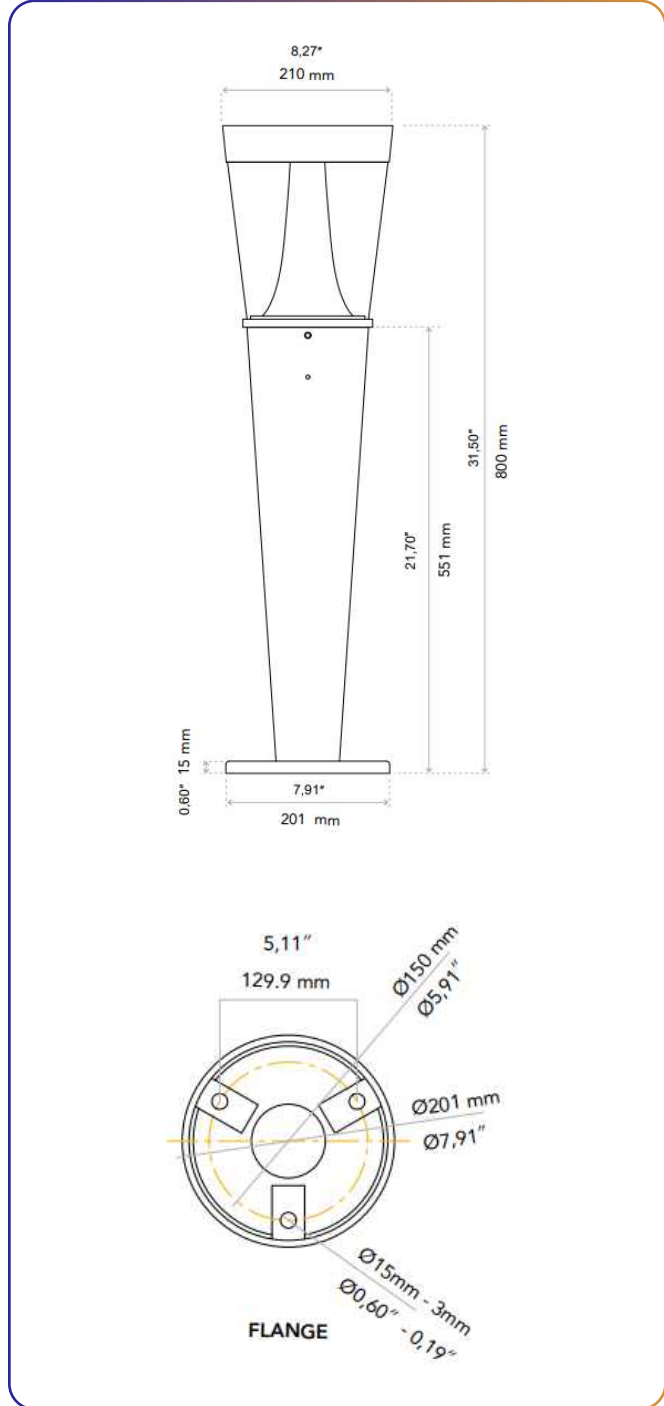

**HOW TO ORDER:**

**CODE:**

**Example:**  
CODE: SL-018-80-BL-23K

SL-018-80-BL-23K

**1 DIMENSIONS:**

-80

-80

Ø: 8.27" (21 cm)

H: 31.50" (80 cm)

**2 FINISH OPTIONS:**

-BL

-BL      Black

**3 CCT:**

-23K      2300K  
-30K      3000K  
-40K      4000K  
-50K      5000K  
-65K      6500K

**ONE WITH THE SUN**

sales@gordonbullard.com

www.bullardsolar.com

1-877-964-4646



991 South Gull Lake Dr

Richland, MI 49083

USA