

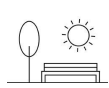

SSLX PRO

**Designed to last
No matter the conditions**

The SSLX PRO series Bullard Solar luminaire delivers a seamless blend of sustainability, performance, and architectural appeal for modern outdoor environments. Powered entirely by solar energy, it provides dependable illumination while reducing energy costs and eliminating the need for trenching or grid connections. Its intelligent control system automatically adapts to environmental conditions, ensuring optimal brightness and extended battery life throughout the night. Designed for long-term durability and minimal maintenance, this fixture is an ideal solution for parks, campuses, boulevards, pedestrian pathways, and smart city projects.



Park & Garden

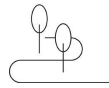

Hiking Trails



Places

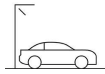

Car Park & Rest

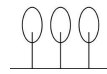

Pathways

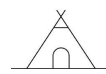

Campsites



FIXTURE TYPE: _____

PROJECT NAME: _____



**5
YEARS**

* Bullard Solar offers a 5 Year Limited Warranty for the Post Top-Series luminaire shall be free from defects in material and workmanship for up to five (5) years from date of shipment. This limited warranty covers all components when installed and operated according to Bullard Solar instructions. Fixture suitable for ambient temperature from -10° to 50°. PV Panels - 20 year performance warranty Controller & Batteries: 5 years

Bullard Solar retains the right to modify or change product specifications without prior notice, as part of our ongoing commitment to improvement

LIGHTING

Efficiency 196 Lumens/Watts
 Chips LED PHILIPS Luxeon 30-30
 LED lifetime Over 80 000 hours LM80
 Optics/CCT TII-S / T3-M/ T-V -- 2300 to 6500K

BATTERY

Technology Lithium Iron Phosphate LIFEPO4
 Autonomy Over 24 hours at full charge - 4 Rainy Days back up
 Charging time 5-6 hours
 Lifespan Over 3000 CYCLES @ 80% DOD over 10 years Lifetime
 Working temp 14°F to 158°F (optional -40°F to 158°F) -10°C to 70°C
 (optional -40°C TO 70°C)

ENERGY

Cells type Monocrystalline Panel Grade A 25 years
 Certificates IEC 61215 - IEC 61730 I and II - IEC 60904

ELECTRONIC

Controller MPPT SMART CONTROLLER (Bullard Solar BRIDGE optional)
 Sensor Microwave 360° Sensor
 Cabling Waterproof Connector, Plug and Play
 Protection Battery Management System (BMS)

OTHER OPTIONS

Pole mounting 8.9cm - 7.6cm (3.50" x 3.00")
 Material Aluminium and Stainless Steel

CERTIFICATIONS

IEC / TUV / EMC / LM-79- 08 AND LM-80 TEST STANDARDS / IK10+ / IP65 / CE / ULOR



Due to the dynamic nature of lighting products and the associated technologies, luminaire data on all specification sheets is subject to change at the discretion of Gordon Bullard LLC and associated companies.

ONE WITH THE SUN

sales@gordonbullard.com / www.bullardbollards.com / 1-877-964-4646

991 South Gull Lake Dr Richland, MI 49083 USA

FIXTURE TYPE: _____

PROJECT NAME: _____

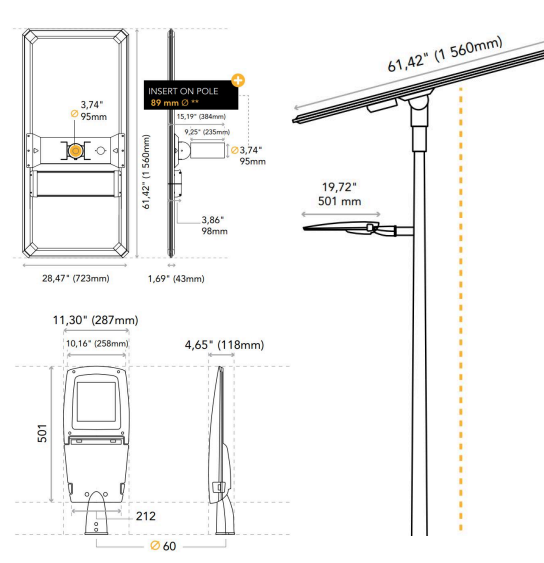
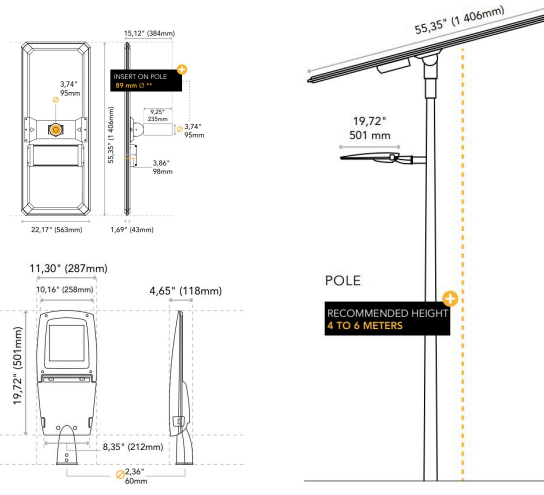
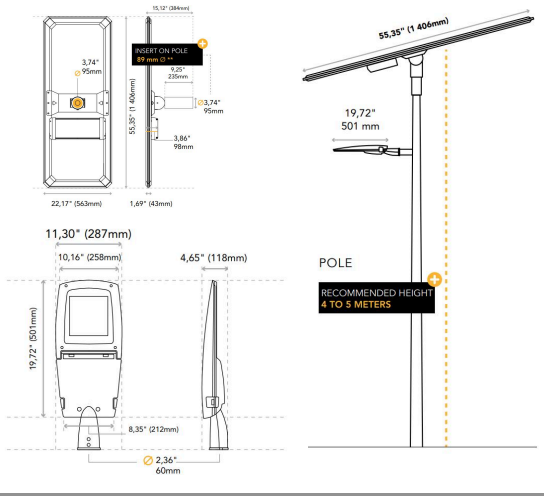

HOW TO ORDER: _____ **CODE:** _____

Example:
CODE: BS-SSLX-PRO-SLX-30-BL-30K

BS-SSLX-PRO-SLX-30-BL-30K

1 MODELS:

-30

DIMENSIONS:

Height - H: 55.51" (141 cm)
Width - W: 22.05" (56 cm)
Base - L: 5.91" (15 cm)

NOMINAL FLUX 5880 LUMENS
NOMINAL POWER 30 WATTS

Light Height From 4m to 5m (From 157.48" to 196.85")
Carton size 146 cm x 61 cm x 26 cm (57.48" x 24.02" x 10.24")
Weight 19.3 KG (42,55 lb)/23.7 KG (52,25 lb)
Capacity 460Wh
Solar panel 125Watts /18V

-40

DIMENSIONS:

Height - H: 55.51" (141 cm)
Width - W: 22.05" (56 cm)
Base - L: 5.91" (15 cm)

NOMINAL FLUX 7840 LUMENS
NOMINAL POWER 40 WATTS

Light Height rom 4 to 6 meters (157.48" x 236.22")
Carton size 146 cm x 61 cm x 26 cm (57.48" x 24.02" x 10.24")
Weight 20.5 KG (45,19 lb)/24 KG (52,91 lb)
Capacity 627Wh
Solar panel 135Watts /18V

-60

DIMENSIONS:

Height - H: 61.42" (156 cm)
Width - W: 28.54" (72.5 cm)
Base - L: 5.91" (15 cm)

NOMINAL FLUX 11 760 LUMENS
NOMINAL POWER 60 WATTS

Light Height From 6 to 8 meters (From 236.22" x 314.96")
Carton size 161 cm x 77 cm x 19.5 cm (63.39" x 30.32" x 7.68")
Weight 27.3 KG (60,19 lb)/33.2 KG (73,19 lb)
Capacity 921Wh
Solar panel 195Watts /18V



Due to the dynamic nature of lighting products and the associated technologies, luminaire data on all specification sheets is subject to change at the discretion of Gordon Bullard LLC and associated companies.

ONE WITH THE SUN

sales@gordonbullard.com / www.bullardbollards.com / 1-877-964-4646
991 South Gull Lake Dr Richland, MI 49083 USA

FIXTURE TYPE: _____

PROJECT NAME: _____

HOW TO ORDER: _____

CODE: _____

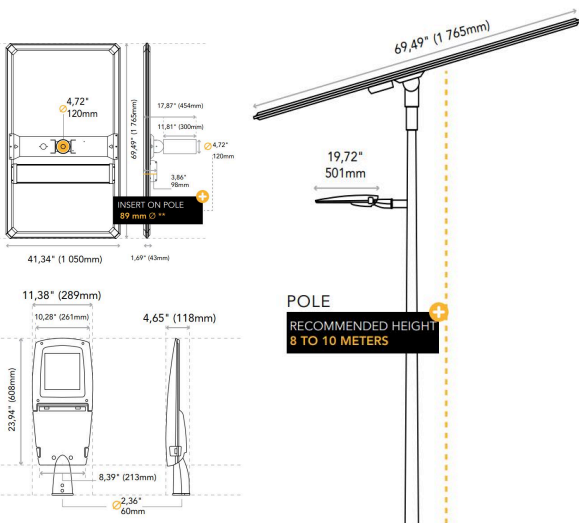
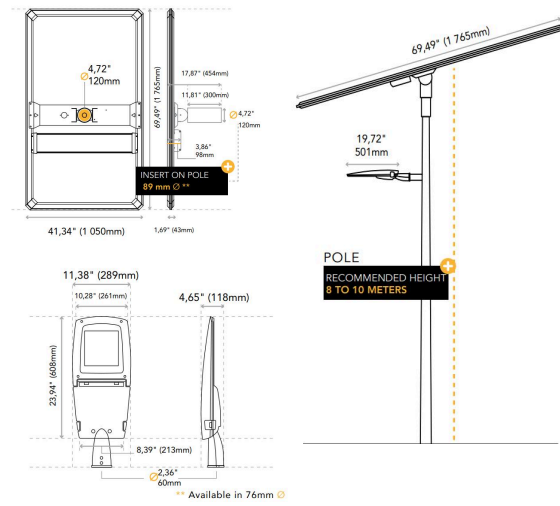
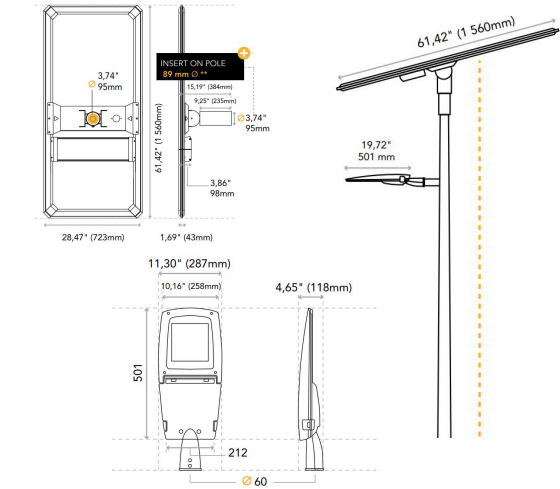

Example:
CODE: BS-SSLX-PRO-SLX-30-BL-30K

BS-SSLX-PRO-SLX-30-BL-30K

1 MODELS:

-80

DIMENSIONS:

Height - H: 61.42" (156 cm)
Width - W: 28.54" (72.5 cm)
Base - L: 5.91" (15 cm)

NOMINAL FLUX 15 680 LUMENS
NOMINAL POWER 80 WATTS

Light Height From 7 to 8 meters (From 275.59" to 314.96")
Carton size 161 cm x 77 cm x 19.5 cm (63.39" x 30.32" x 7.68")
Weight 28.5 KG (62,83 lb)/34.5 KG (76,06 lb)
Capacity 1152 Wh
Solar panel 210Watts /18V

-100

DIMENSIONS:

Height - H: 69.69" (177 cm)
Width - W: 41.73" (106 cm)
Base - L: 5.91" (15 cm)

NOMINAL FLUX 19 600 LUMENS
NOMINAL POWER 100 WATTS

Light Height From 8 to 10 meters (From 314.96" to 393.70")
Carton size 182.5 cm x 111 cm x 25.5 cm (71.85" x 43.70" x 10.04")
Weight 40.5 KG (89,29 lb)/46.5 KG (102,52 lb)
Capacity 1498 Wh
Solar panel 285Watts /18V

-120

DIMENSIONS:

Height - H: 69.69" (177 cm)
Width - W: 41.73" (106 cm)
Base - L: 5.91" (15 cm)

NOMINAL FLUX 23 520 LUMENS
NOMINAL POWER 120 WATTS

Light Height From 8 to 10 Meters (From 314.96" to 393.70")
Carton size 182.5 cm x 111 cm x 25.5 cm (71.85" x 43.70" x 10.04")
Weight 40.5 KG (89,29 lb)/46.5 KG (102,52 lb)
Capacity 1843 Wh
Solar panel 285Watts /18V



Due to the dynamic nature of lighting products and the associated technologies, luminaire data on all specification sheets is subject to change at the discretion of Gordon Bullard LLC and associated companies.

ONE WITH THE SUN

sales@gordonbullard.com / www.bullardbollards.com / 1-877-964-4646

991 South Gull Lake Dr Richland, MI 49083 USA

FIXTURE TYPE: _____

PROJECT NAME: _____

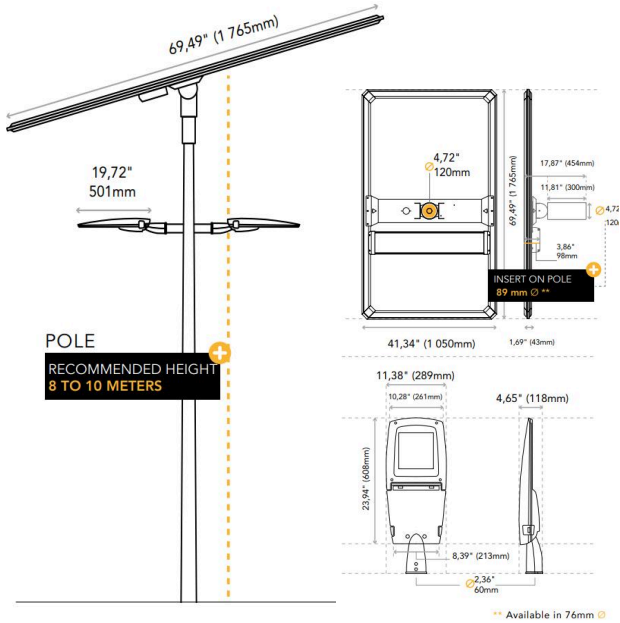

HOW TO ORDER:

CODE:

Example:
CODE: BS-SSLX-PRO-SLX-30-BL-30K

BS-SSLX-PRO-SLX-30-BL-30K

1 MODELS:

-D50

DIMENSIONS:

Height - H: 69.69" (177 cm)
Width - W: 41.73" (106 cm)
Base - L: 5.91" (15 cm)

NOMINAL FLUX2 x 9800 LUMENS
NOMINAL POWER2.x 50 WATTS

Light Height From 6 to 10 meters (From 236.22" to 393.70")
Carton size (71.85" x 43.70" x 10.04") 182.5 cm x 111 cm x 25.5 cm
Weight 40.5 KG (89,29 lb)/46.5 KG (102,52 lb)
Capacity 1498 Wh
Solar panel 285 Watts /18V

2 FINISH OPTIONS:

-BL Black
-CUS Custom on request

3 CCT:

-23K 2300K
-30K 3000K
-40K 4000K
-50K 5000K
-65K 6500K



Due to the dynamic nature of lighting products and the associated technologies, luminaire data on all specification sheets is subject to change at the discretion of Gordon Bullard LLC and associated companies.

ONE WITH THE SUN

sales@gordonbullard.com / www.bullardbollards.com / 1-877-964-4646

991 South Gull Lake Dr Richland, MI 49083 USA

FIXTURE TYPE: _____

PROJECT NAME: _____

LUMINAIRE HOUSING & LEDS

Extruded low-copper aluminum. Protection class (IP65). Bullard Solar uses a high quality Polyester Powder Coating from AKZO NOBEL. This powder coating provides an excellent salt and humidity resistance as well as ultra violet resistance for color retention for this product. Our Luminaire is equipped with PHILIPS LUXEON HE PLUS High efficiency Chips offering an overall 196 Lumens per Watt efficacy. Our luminaire also complies with the DARK SKY requirement for light pollution with an Upward lighting of 0.31%.



LED	3030	LED QTY (PCS)	96	LENS (PCS)	4	CRI	> 80
-----	-------------	---------------	-----------	------------	----------	-----	----------------

DIFFERENT OPTICS *

Our different optics will allow you to optimize the lighting results of your projects

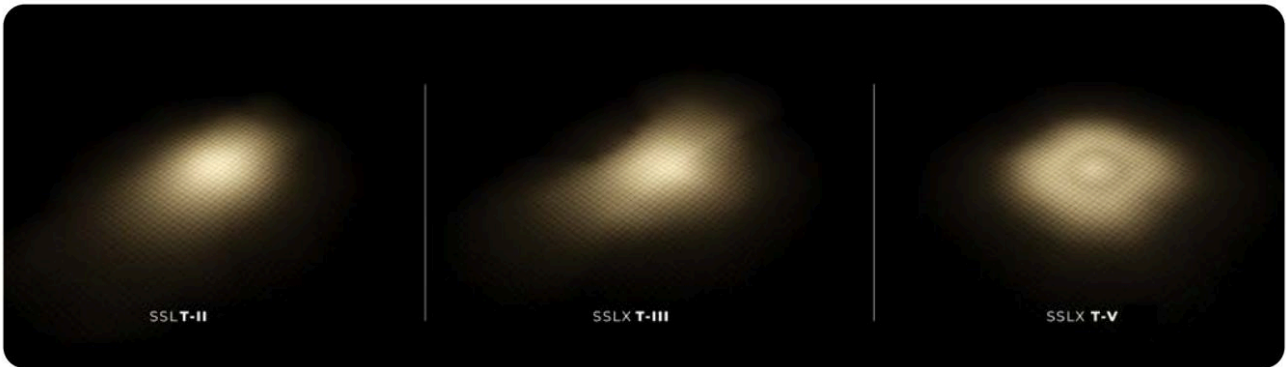

* Please contact us for more optics.

LIGHT DISTRIBUTION CURVES

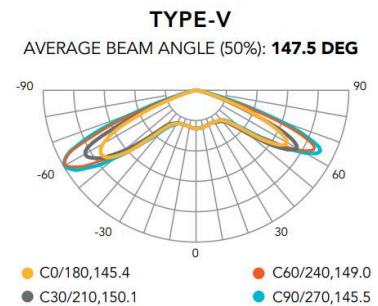
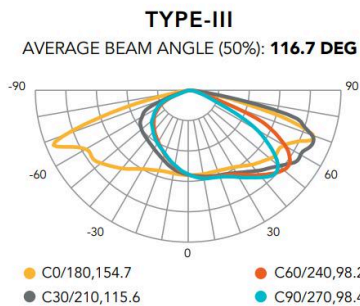
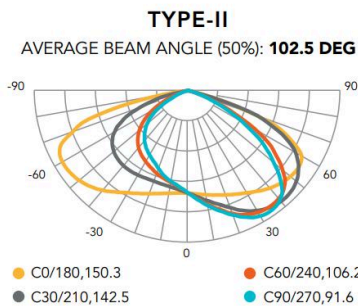

Due to the dynamic nature of lighting products and the associated technologies, luminaire data on all specification sheets is subject to change at the discretion of Gordon Bullard LLC and associated companies.

ONE WITH THE SUN

sales@gordonbullard.com / www.bullardbollards.com / 1-877-964-4646

991 South Gull Lake Dr Richland, MI 49083 USA

FIXTURE TYPE: _____

PROJECT NAME: _____

+ OVER 10 YEARS LIFESPAN

The SSLXPRO Series is equipped with Iron Phosphate Lithium LiFePo4 battery. This technology is proved to be the best chemical technology for solar application on the market. With a cycle life of over 3000 Cycles @ 80% DOD, the battery enjoys lifespan of over 10 years.

EXTREME TEMPERATURE

14°F to 158°F / -10 °C to 70°C

When Standard Lithium LiFePo4 batteries enjoy a working temperature range from 14°F to 158°F (-10°C TO 70°C). Bullard Solar offers as optional a new Special LIFEPO4 battery with working range of -40°F to 158°F (-40 °C. to 70 °C).

EASY MAINTENANCE & ANTI THEFT SCREWS

Easy and direct access to the battery casing for maintenance. The fixation are made with anti theft screws, which request special tooling to unscrew.

**BMS ELECTRONIC PROTECTION
BATTERY MANAGEMENT SYSTEM**

Our batteries are equipped with electronic circuit boards for a higher protection, ensuring battery functioning optimization no matter the situation.

THE BMS PROTECTS AGAINST

- OVER/UNDER CURRENT • OVERLOAD • OVER/UNDER VOLTAGE
- OVER/UNDER CHARGE • TEMPERATURE MANAGEMENT

BATTERY LIFEPO4

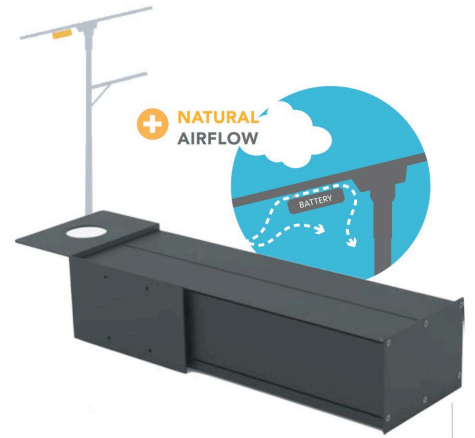

ALUMINUM WATERPROOF CASING & NATURAL AIRFLOW

High temperatures greatly negatively affect the battery's lifespan. This is why our batteries are encapsulated in an aluminum waterproof casing for a perfect heat dissipation. In addition to that, the casing enjoys a natural airflow which keeps the battery to ambient temperature.

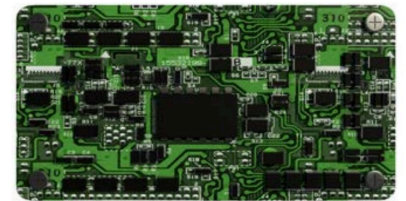

COMPARISONS OF DIFFERENT BATTERY TECHNOLOGIES

LIFETIME & CYCLES AT 80% DOD*
Comparison of different battery technologies



Lead Acid
200



NimH
700



Lithium ION
800



Lithium LifePO4
3 000

CHARGING TEMPERATURE RANGE WITHOUT CAPACITY LOSS
Minimum & Maximum temperature range for Optimal charging during the day

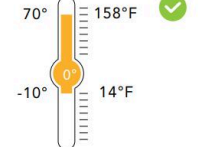
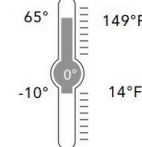
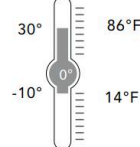
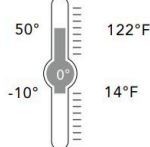

Due to the dynamic nature of lighting products and the associated technologies, luminaire data on all specification sheets is subject to change at the discretion of Gordon Bullard LLC and associated companies.

ONE WITH THE SUN

sales@gordonbullard.com / www.bullardbollards.com / 1-877-964-4646

991 South Gull Lake Dr Richland, MI 49083 USA

FIXTURE TYPE: _____

PROJECT NAME: _____

SOLAR PANEL

High efficiency mono-crystalline Solar panels. Carefully selected Grade A Solar cells. Up to 20.4% efficiency, all protected by self-cleaning tempered glass at 30 degrees of inclination. Its octagonal Anodized aluminium alloy frame gives it a modern and elegant design as well as perfect resistance to corrosion. They are also equipped with fully waterproof Plug and Play connectors.

solar cells
GRADE A



OUR PV PERFORMANCE GUARANTEE

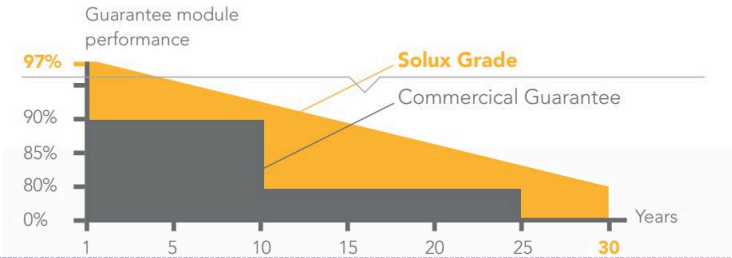

CONTROLLER MPPT



+ WATERPROOF CONNECTORS
"PLUG & PLAY"

All our components are assembled **seamless and easy to access**

In a search for performance and reliability, our products are equipped with MPPT technology controller offering the best charging efficiency on the market up to 98%

REMOTE CONTROL MONITORING

In order to facilitate all maintenance operations and above all to diagnose any possible problem, without having to intervene mechanically on the luminaire, BULLARD SOLAR luminaires are equipped with a wireless diagnostic system via remote control



With a simple click it is possible to have real-time information such as:

- Automatic diagnosis in case of malfunction
- State of charge and battery history
- Real Time load and solar panel energy production history
- Age of the product and installation Temperature and its history

FEATURES

- Minimal stand-by power consumption
- Current consumption $\leq 10\text{mA}$
- Intelligent battery management

3 Phases charging:

- Charge MPPTT
- Constant voltage
- Floating voltage

- Intelligent LED driver Auto detecting of Dusk and Dawn for automatic operation, 7 Lighting Programs Configuration.
- ANTI BLACK OUT: Load adjust according to battery capacity assuring all night long lighting in any weather conditions.
- The controller also acts against:

- OVERLOAD
- OVERCURREN
- OVERTEMPERATURE
- OVERVOLTAGE / OVERLOAD
- OVERDISCHARGE



Due to the dynamic nature of lighting products and the associated technologies, luminaire data on all specification sheets is subject to change at the discretion of Gordon Bullard LLC and associated companies.

ONE WITH THE SUN

sales@gordonbullard.com / www.bullardbollards.com / 1-877-964-4646

991 South Gull Lake Dr Richland, MI 49083 USA

FIXTURE TYPE: _____

PROJECT NAME: _____

MOTION SENSOR MICROWAVE

Bullard Solar luminaires are equipped with microwave sensors that use the Doppler effect (like car radars) to detect a near-by objects and measure the distance. The sensor emits a high frequency wave to reflect off of and analyze the objects in the vicinity. Since the microwaves only detect specific objects, detection reliability increases resulting in:

- Much better reliability compared to the Infrared sensor
- Up to 360° Directivity
- Insensitivity to other environmental variations such as light, color, temperature, etc.

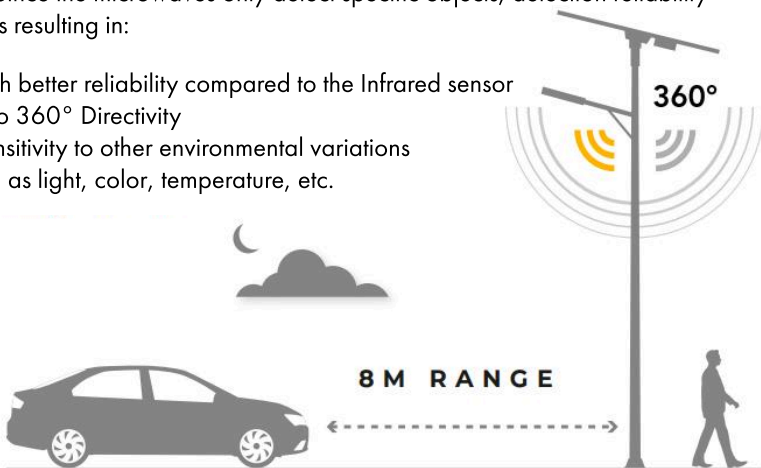

OPERATION MODE & LIGHTING SCHEDULE

In addition to automatic switching on and off, you have the possibility of choosing among different modular operating modes according to the needs of the project

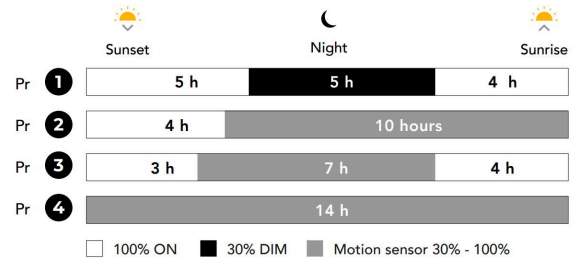

CONTACT US FOR MORE PROGRAM OPTIONS

BULLARD SOLAR BRIDGE REMOTE MONITORING

As part of his continuous effort for development, the Bullard Solar team is proud to have developed a special tool for remote monitoring of our solar street light. Bullard Solar Bridge uses low frequency technology LORA or ZIGBEE to monitor in real time a batch of solar street lights. YOU CAN NOW MANAGE YOUR SOLAR PARK REMOTELY:

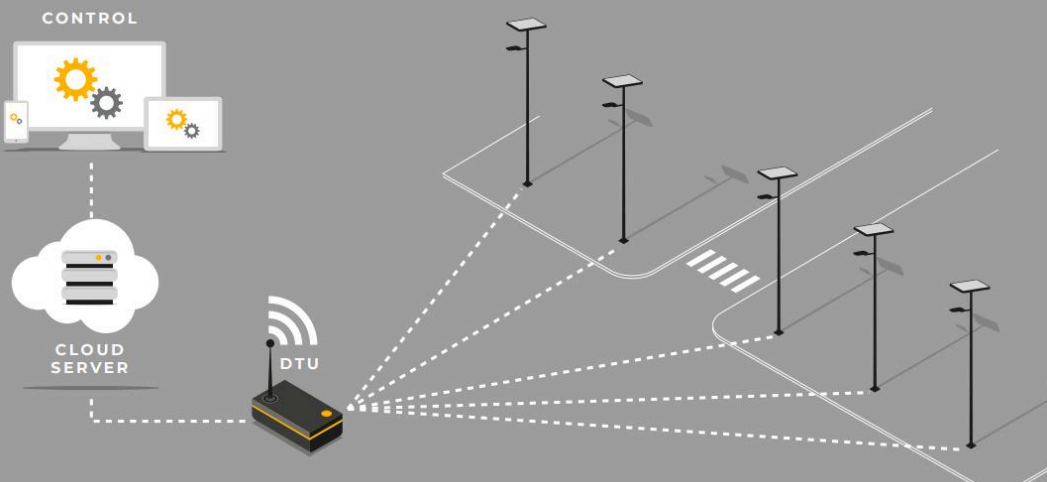

- INTERNET 2G/3G/4G
- CONNECTION SECURE
- GREAT RANGE OF COMMUNICATION
- LOW CONSUMPTION



Due to the dynamic nature of lighting products and the associated technologies, luminaire data on all specification sheets is subject to change at the discretion of Gordon Bullard LLC and associated companies.

ONE WITH THE SUN

sales@gordonbullard.com / www.bullardbollards.com / 1-877-964-4646

991 South Gull Lake Dr Richland, MI 49083 USA

FIXTURE TYPE: _____

PROJECT NAME: _____

EASY INSTALLATION

NO CABLING | NO TRENCHING

With a well designed bracket support SSLXPRO is effortless and flexible to install. Free 360° rotation of the panel to always face the Sun



INSERT, ORIENTATE & CHOOSE YOUR TILT

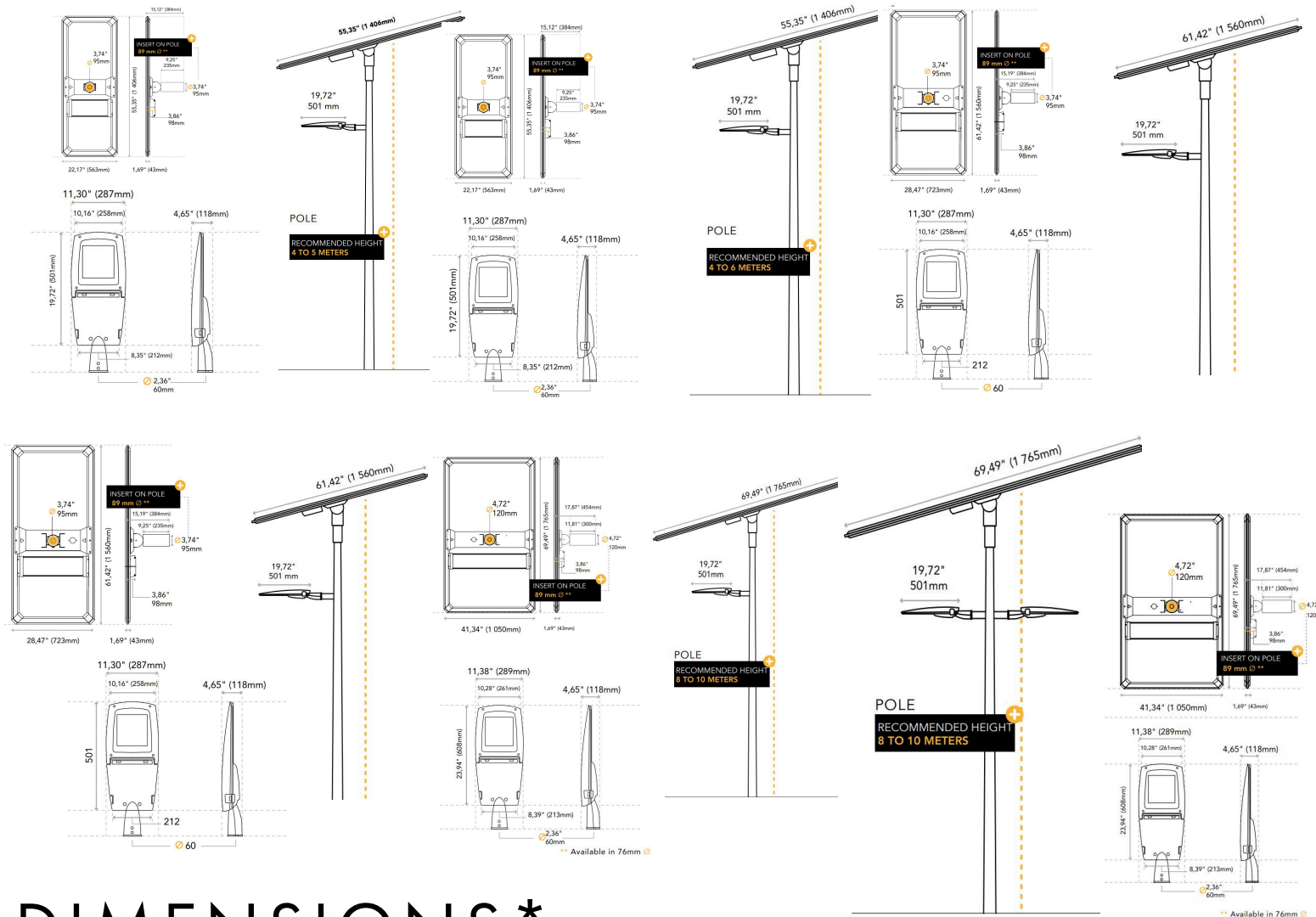

DIMENSIONS*

SOLAR PANEL & LED



Due to the dynamic nature of lighting products and the associated technologies, luminaire data on all specification sheets is subject to change at the discretion of Gordon Bullard LLC and associated companies.

ONE WITH THE SUN

sales@gordonbullard.com / www.bullardbollards.com / 1-877-964-4646
991 South Gull Lake Dr Richland, MI 49083 USA