



**BULLARD
SOLAR**
One with the Sun

**MARA
SOLAR BOLLARD**





FIXTURE TYPE: _____

PROJECT NAME: _____



CERTIFICATIONS **IEC / TUV / EMC / LM-79- 08
AND LM-80 TEST STANDARDS
/ IK8 / IP65 / CE / ULOR**

**5
YEARS**

Bullard Solar offers a 5 Year Limited Warranty for the Solar Bollard-Series luminaire to be free from defects in material and workmanship for up to five (5) years from date of shipment. This limited warranty covers all components when installed and operated according to Bullard Solar instructions. Fixture suitable for ambient temperature from -10° to 50°. PV Panels - 20 year performance warranty Controller & Batteries: 5 years

GENERAL INFORMATION:

Designed in aluminum and treated to withstand the harshest conditions, the MARA by BULLARD SOLAR will be perfect for all your lighting, marking, and beautification applications for your outdoor living spaces with total energy autonomy. Equipped with high-efficiency solar cells, the light fixture charges in the sun but also in cloudy weather, ensuring optimal lighting throughout the year.

NOMINAL FLUX	420 LUMENS
NOMINAL POWER	3.5 WATTS

LIGHTING

Efficiency	120 Lumens/Watts
Chips LED	PHILIPS Luxeon 30-30
LED lifetime	Over 80 000 hours LM80
Optics/CCT	T-V / 2300K to 6500K (Dual CCT optional)
Light Height	31.50" (80 cm)

BATTERY

Technology	Lithium Iron Phosphate LIFEPO4
Capacity	28Wh
Autonomy	Over 24 hours at full charge - 4 Rainy Days back up
Charging time	6 hours
Lifespan	Over 3000 CYCLES @ 80% DOD over 10 years Lifetime
Working temp	14° F to 158° F (optional -40° F to 158 °F) -10°C to 70°C (optional -40°C TO 70°C)

ENERGY

Solar panel	6 Wc
Cells type	Monocrystalline Panel Grade A 25 years
Certificates	IEC 61215 - IEC 61730 I and II - IEC 60904

ELECTRONIC

Sensor..... PIR 180° sensor (optional)

DIMENSIONS

Product	D: 8.66" x H: 31.50" (D: 22 cm x H: 80 cm)
Carton size	33.86" x 10.63" x 11.02" (86 cm x 27 cm x 28 cm)
Weight	15,00 lb (6.8 KG)
Materials	Die cast aluminum
Installation	Concrete base or insert on support
Product code	<u>BS-SL019-SLX</u>

Bollard Solar retains the right to modify or change product specifications without prior notice, as part of our ongoing commitment to improvement

ONE WITH THE SUN

sales@gordonbullard.com
www.bullardsolar.com
1-877-964-4646



991 South Gull Lake Dr
Richland, MI 49083
USA



**BULLARD
SOLAR**
One with the Sun

CODE:
BS-SL019-SLX

FIXTURE TYPE: _____

PROJECT NAME: _____

 IP65

LUMINAIRE & LEDS

The MARA bollard incorporates the latest LED technologies, its elegance and ease of installation will meet your lighting needs. MARA is equipped with LED chips, combining performance and robustness with 120 lumens per watt.

A TOTAL OF 420 LUMENS

Our light fixture also complies with current standards concerning light pollution.



SYMMETRICAL DISTRIBUTION

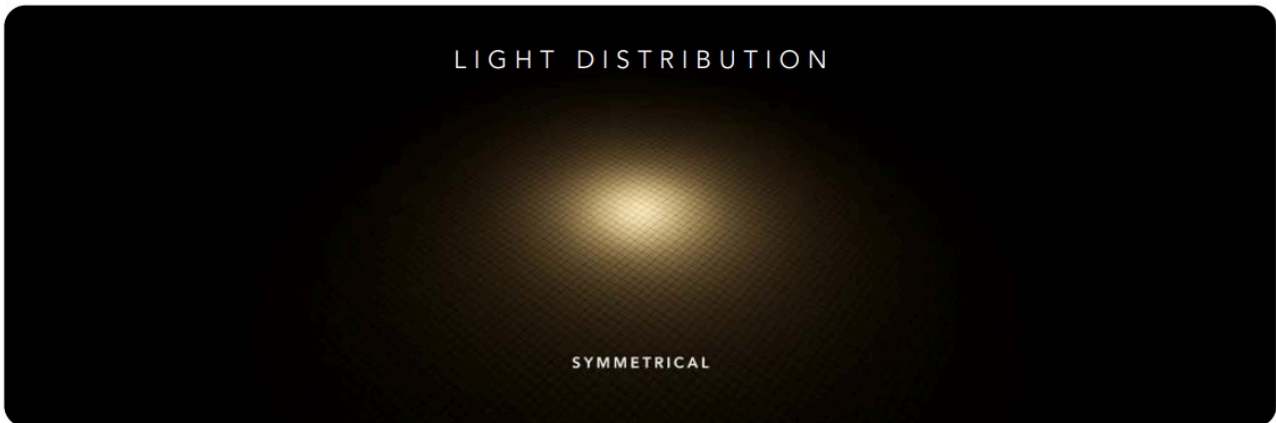

PHOTOMETRIC CURVE

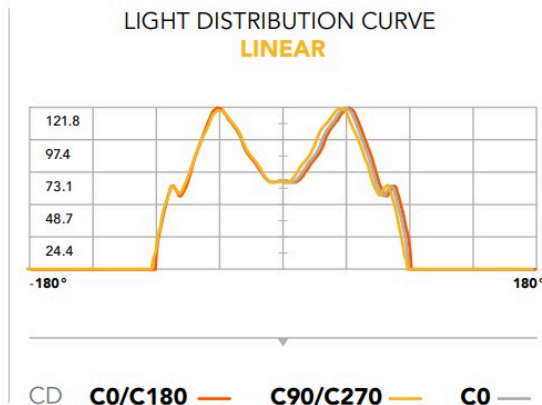
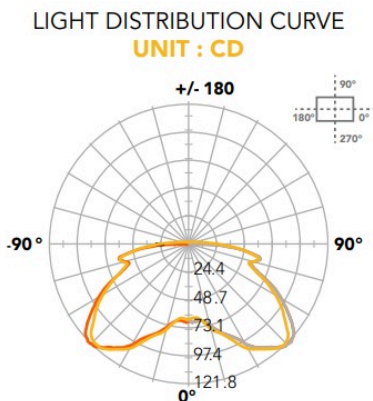

ONE WITH THE SUN

sales@gordonbullard.com
www.bullardsolar.com
1-877-964-4646



991 South Gull Lake Dr
Richland, MI 49083
USA



**BULLARD
SOLAR**
One with the Sun

CODE:
BS-SL019-SLX

FIXTURE TYPE: _____

PROJECT NAME: _____

OVER 10 YEARS LIFESPAN

The MARA bollard is equipped with Lithium Iron Phosphate LIFEPO4 batteries, recognized as the best battery technology in terms of longevity, safety, and performance for solar applications. Our batteries enjoy a lifespan of over 3000 cycles, which is more than 10 years at 80% DOD.

BATTERY LIFEPO4



EXTREME TEMPERATURE

14°F to 158°F
-10 °C to 70°C

While standard batteries benefit from an operating temperature of -10°C to 70°C, Bullard Solar offers as optional a new Special LIFEPO4 battery with working range of -40°F to 158°F / -40°C to 70°C.

BMS ELECTRONIC PROTECTION BATTERY MANAGEMENT SYSTEM

Our batteries are equipped with electronic circuit boards for a higher protection, ensuring battery functioning optimization in any situation.

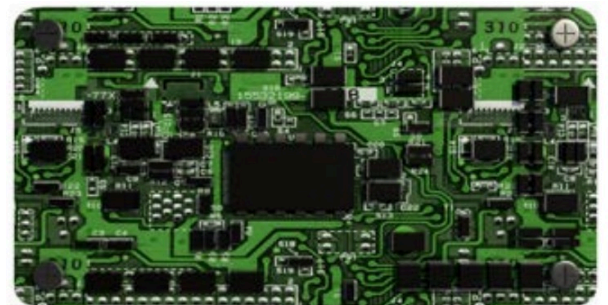

THE BMS PROTECTS AGAINST

- OVER/UNDER CURRENT • OVERLOAD • OVER/UNDER VOLTAGE
- OVER/UNDER CHARGE • TEMPERATURE MANAGEMENT

COMPARISONS OF DIFFERENT BATTERY TECHNOLOGIES

LIFETIME & CYCLES AT 80% DOD*
Comparison of different battery technologies



Lead Acid
200



NimH
700



Lithium ION
800



Lithium LifePO4
3 000

**CHARGING TEMPERATURE RANGE
WITHOUT CAPACITY LOSS**
*Minimum & Maximum temperature range for
Optimal charging during the day*

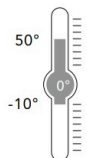

Lead Acid

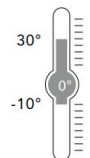

NimH

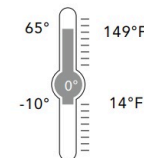

Lithium ION

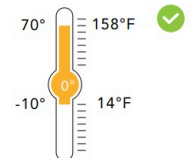

Lithium LifePO4

ONE WITH THE SUN

sales@gordonbullard.com
www.bullardsolar.com
1-877-964-4646



991 South Gull Lake Dr
Richland, MI 49083
USA

FIXTURE TYPE: _____

PROJECT NAME: _____

Solar cells **GRADE A**

SOLAR PANEL

6 WATTS

Encapsulated Monocrystalline Solar Panel Grade A Solar Cell with Tempered Glass.

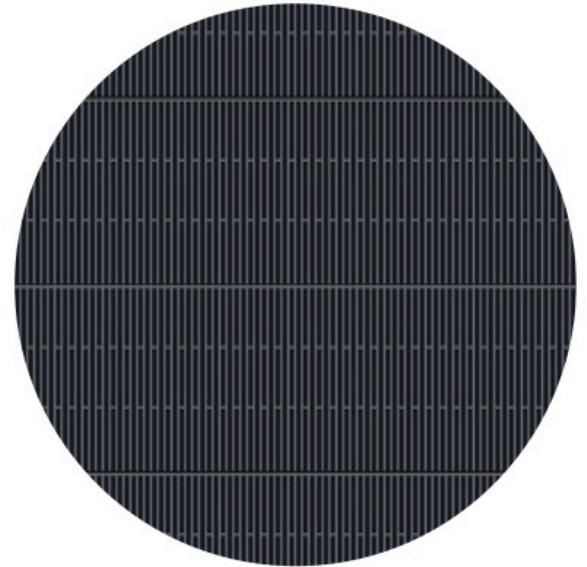

OUR PV PERFORMANCE GUARANTEE

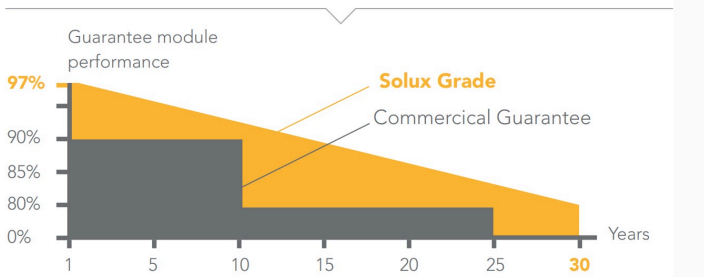

PRESENCE DETECTOR INFRA-RED SENSOR

THE MARA BOLLARD AUTOMATICALLY TURNS ON AT DUSK AND OFF AT DAWN.

BULLARD SOLAR offers optional PIR movement sensor. The infra red detector integrated into the light fixture will increase the light power as pedestrians or vehicles pass, thus providing a higher level of safety while respecting the environment.

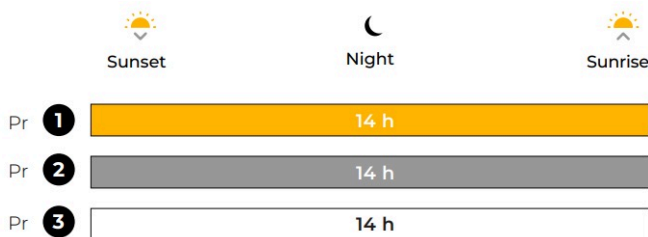
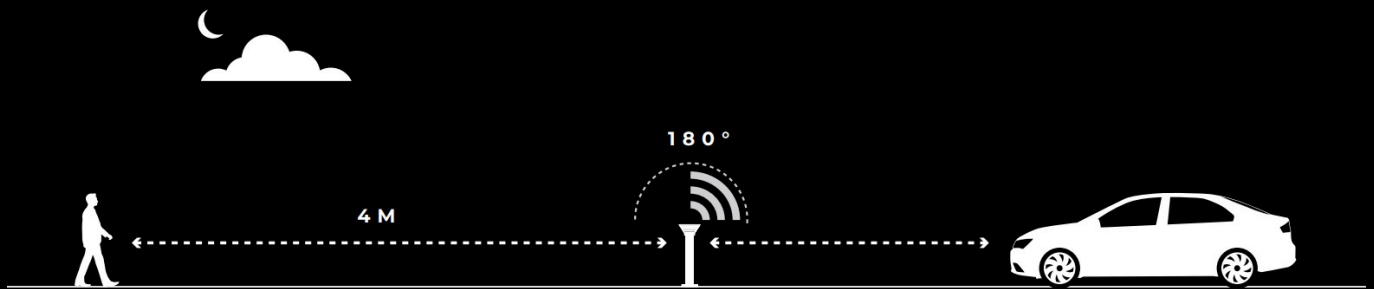

Depending on the geographical area, we will select the % of light reduction.

- **Program 1** > 40% Dim + 100% ON during 20 sec
- **Program 2** > 30% Dim + 100% ON during 20 sec
- **Program 3** > 20% Dim + 100% ON during 20 sec

ONE WITH THE SUN

sales@gordonbullard.com
www.bullardsolar.com
1-877-964-4646



991 South Gull Lake Dr
Richland, MI 49083
USA



**BULLARD
SOLAR**
One with the Sun

CODE:
BS-SL019-SLX

FIXTURE TYPE: _____

PROJECT NAME: _____

EASY INSTALLATION

NO CABLING & TRENCHING

No wiring or trenching is necessary, you just need to embed the MARA on anchor rods.

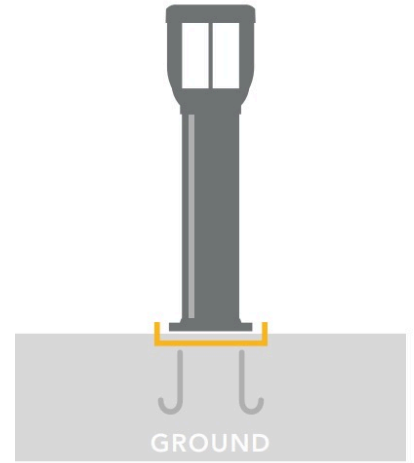

FLAT MOUNT

DIMENSIONS

BOLLARD AND BASE

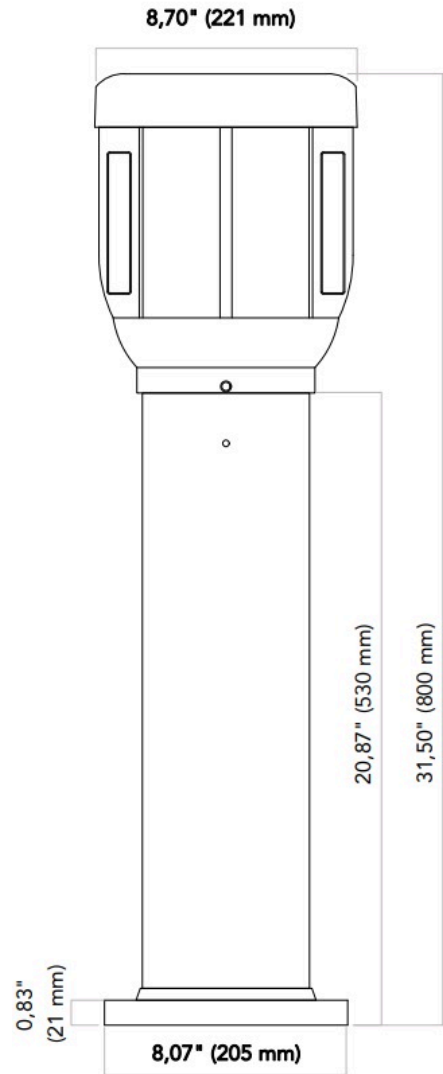
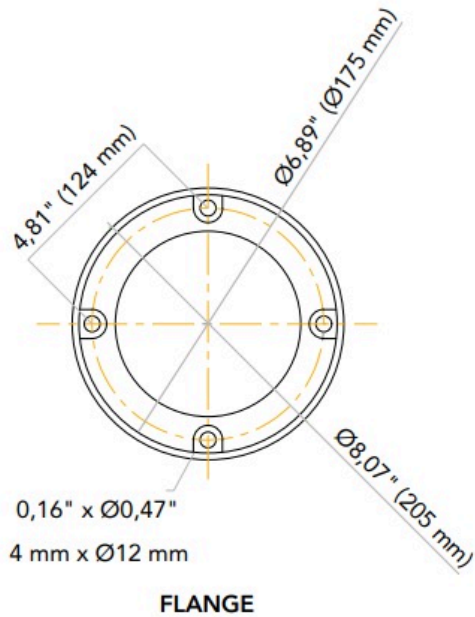

ONE WITH THE SUN

sales@gordonbullard.com
www.bullardsolar.com
1-877-964-4646



991 South Gull Lake Dr
Richland, MI 49083
USA

Due to the dynamic nature of lighting products and the associated technologies, luminaire data on all specification sheets is subject to change at the discretion of Gordon Bullard LLC and associated companies.

© Bullard & Company 2025 All Rights Reserved

Updated 07/30/2025



FIXTURE TYPE: _____

PROJECT NAME: _____

HOW TO ORDER:

CODE:

Example:
CODE: BS-SL019-SLX-23K

BS-SL019-
SLX-23K

1 DIMENSIONS:

Ø: 8.66" (Ø: 22 cm) x H: 31.50" (H: 80 cm)

2 FINISH OPTION:

Grey

3 CCT:

-23K	2300K
-30K	3000K
-40K	4000K
-50K	5000K
-65K	6500K

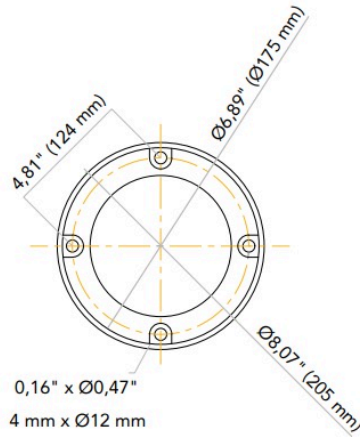

FLANGE

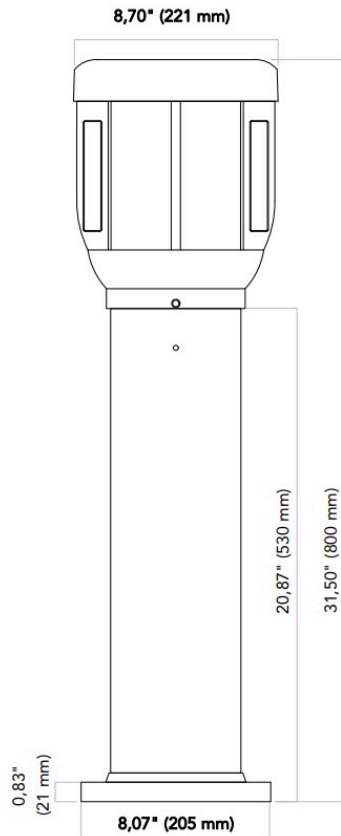

ONE WITH THE SUN

sales@gordonbullard.com
www.bullardsolar.com
1-877-964-4646



991 South Gull Lake Dr
Richland, MI 49083
USA