

**BULLARD
SOLAR**
One with the Sun



DOMO

INSTALLATION TYPE:
BOLLARDS



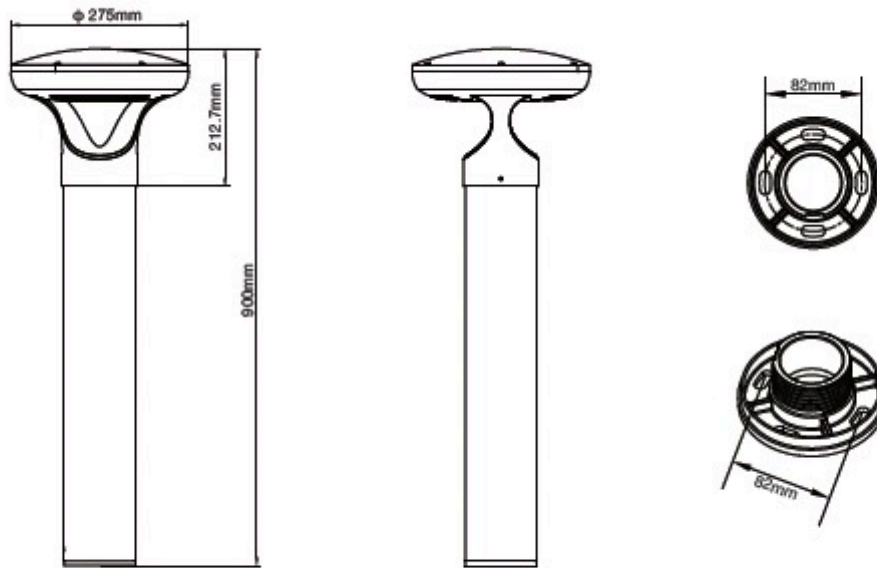

Specification

Solar panel	6.2Watts 5V MONO
LiFePO4 battery	38.4WH 3.2V
LED power	1.5W max
Luminous output(lm)	280lm
Motion sensor type	Microwave
Color temperature	2700K~6000K
Light size	Φ275mm H:900mm
Certificates	CE, ROHS, IP65,FCC
Working program	2H100%+5H(30%+70%)+4H 20%+6H(10%+40%)
Warranty	3 years

Notice : Please charge the light fully every 3 months if it is not sold to remain its performance.

Accessories in package



Expansion Screw : 4 pieces
To tighten the base to ground. It is M6*60



Allen Wrench : 1 piece
Used for tightening screws

sales@gordonbullard.com
www.bullardsolar.com
1 877-964-4646



991 South Gull Lake Dr.
Richland, MI 49083
USA

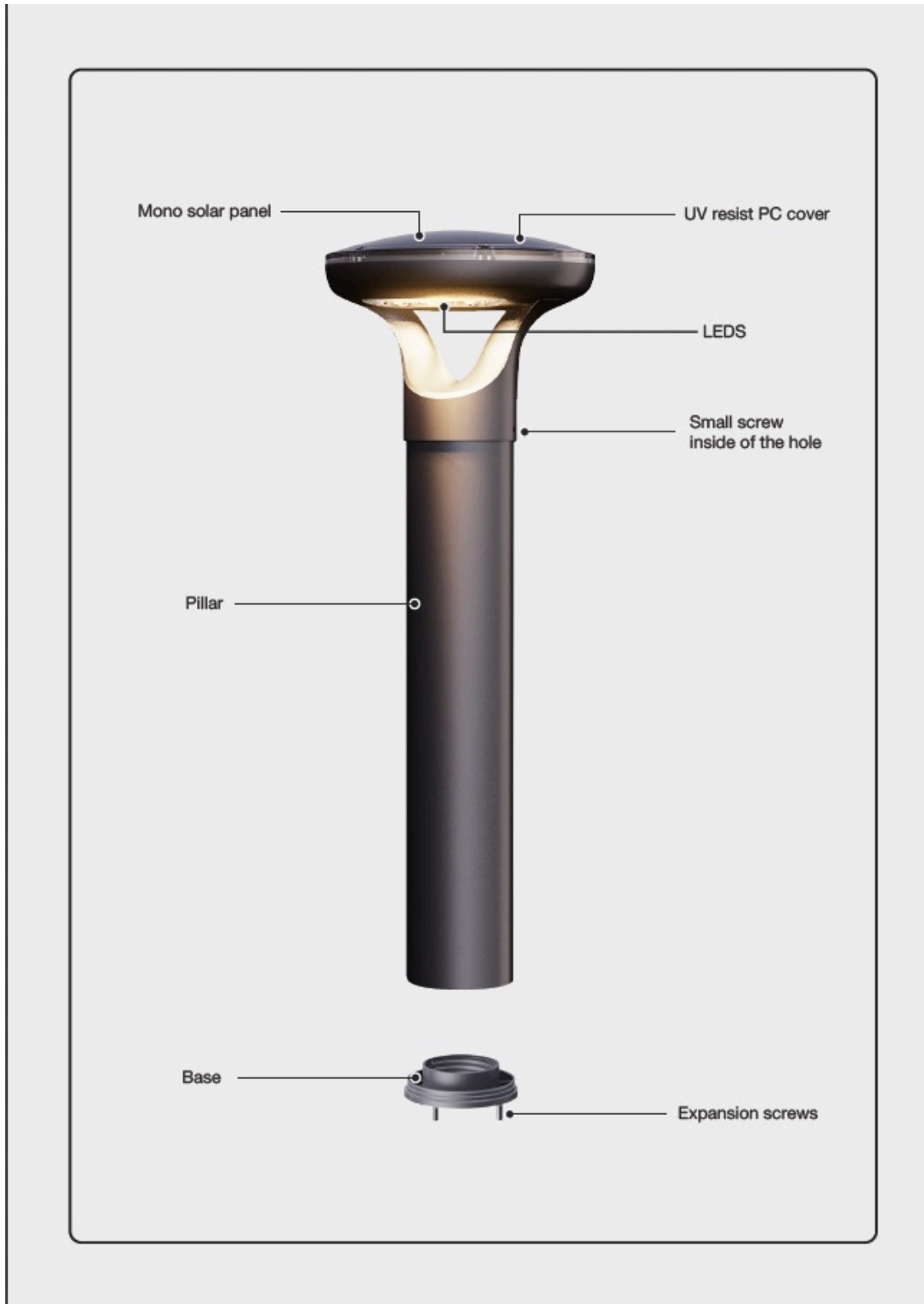

sales@gordonbullard.com
www.bullardsolar.com
1 877-964-4646



991 South Gull Lake Dr.
Richland, MI 49083
USA

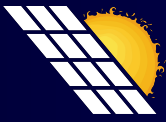

How to install the light

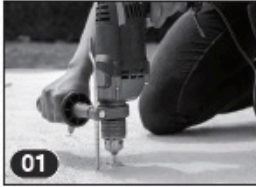

01
Drill 4 holes in on the surface according to the size as base dimension shows.



02
Take off the base from the pillar and install it to the surface with 4 screws according to the required lighting direction. (very important step)



03
Screw the light head to the pillar properly. (If the light head is separately packed .)

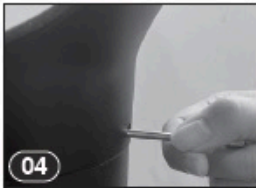

04
Use the small screw driver to tighten the screw inside of light head to lock it tightly.

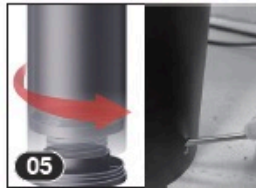

05
Screw the light body to the base properly and tighten the small screw at the bottom of the pillar to avoid the losing of light body.



The installation direction of the base directly determines the direction of the lighting. The light will shine in the direction opposite to the sawtooth

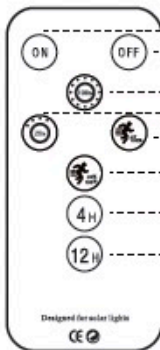

- Turn ON the light
- Turn OFF the light
- Factory default setting
- Low power for full night operation.
- Light turns ON when sensor is triggered for full night
- Lights turns brighter when sensor is triggered for full night
- Set the light work for 4 hours only.
- Set the light work for 12 hours only

Regular Trouble Shot

Problem	Reason	How to solve
Light is off	Switch is off	Turn on the on/off switch of light
	No direct sunshine	Move the light to the direct sunny area
	Continuous cloudy or rainy days	Light will back to work when sun returns
	There is debris on solar panel	Clean the solar panel
Short working time	Location problem	Move the light to the area with direct sunshine
	Continuous cloudy or rainy days	Light will be recharged when sun returns
	Battery life is expired	Replace with a new battery

sales@gordonbullard.com
www.bullardsolar.com
1 877-964-4646



991 South Gull Lake Dr.
Richland, MI 49083
USA